

JESI 3D2S

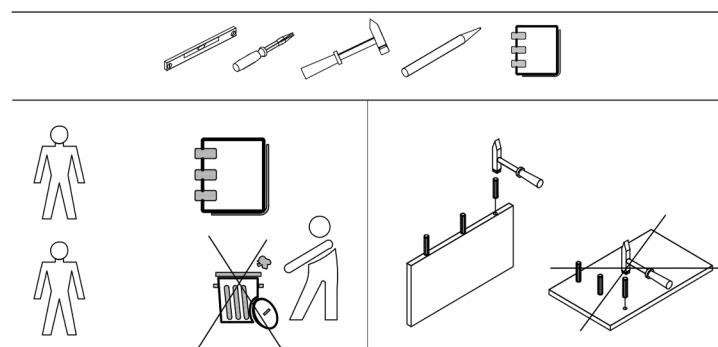

Navodila za uporabo.

Priporočljivo je, da ob nakupu razpakiranega izdelka v trgovini preverite njegovo kakovost in popolnost. Izdelek je treba sestaviti tako, kot je opisano v tem priročniku. Medtem ko je izdelek v uporabi, je treba občasno zategniti ohlapne vijačne povezave. Če je treba premikati predmete po stanovanju, morate pred premikanjem izdelek popolnoma sprostiti z bremena (ležišča). Da bi preprečili poškodbe obstoječih nosilcev, je treba izdelek pred premikanjem dvigniti. Pohištvo ne sme biti izpostavljeno stiku z vodo. Brisanje prahu iz izdelka je treba opraviti z rahlo vlažno mehko krpo. Da bi preprečili deformacijo delov in spremembo barve izdelkov, pohištva ne nameščajte na neposredno sončno svetlobo.

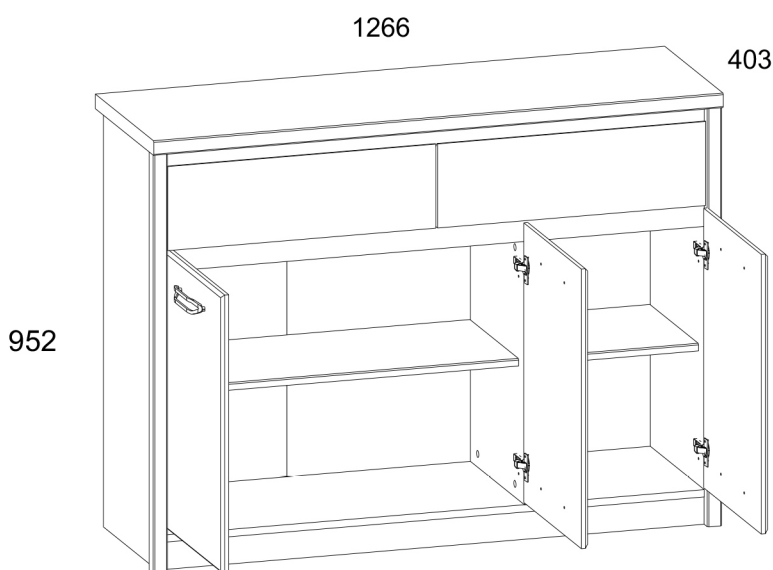



















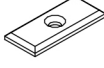

Medtem ko je izdelek v uporabi, je **PREPOVEDANO**:

- nameščati pohištvo v bližini grelnih naprav, blizu surovih sten in v prostorih z relativno vlažnostjo nad 70 %;
- segrevati elementov pohištva na temperaturo, višjo od 40 C;
- med sestavljanjem in uporabo kompleta izdelkov stopati na vodoravne ščite in okna;
- uporabljati kemičnih čistil za čiščenje pohištva;

Garancija proizvajalca.

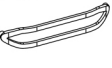
1. Garancijski rok za uporabo izdelka - 24 mesecev od datuma prodaje. V garancijskem roku proizvajalec zagotavlja popravilo ali zamenjavo izdelkov, če uporabnik ni kršil pravil uporabe.
2. Reklamacije mora potrošnik vložiti neposredno pri trgovski organizaciji, v kateri je bilo pohištvo kupljeno, pri čemer mora predložiti "Navodila za uporabo" in kopijo potrdila o prodaji.
3. Izdelek, bočna omara 3D2S, ki je del sklopa "JAZZ", izpolnjuje 2 zahteve standarda GOST 16371-2014, TR TS 025/2012.
4. Življenjska doba pohištva je 5 let.
5. Proizvajalec si pridržuje pravico do sprememb v zasnovi izdelka, ne da bi pri tem ogrozil njegove zahteve glede zasnove in uporabe.
6. Za sestavljanje izdelkov je priporočljivo pritegniti usposobljeno osebje. To je pomembno! Navodila shranite za primer ponovne montaže pohištva ali reklamacije. Pri uveljavljanju reklamacije uporabite zapis iz navodila.

Koda	Dimenzije				Paket
13	1266	403	32	1	1/4
32	1200	355	16	1	3/4
33	1200	371	16	1	3/4
73	798	335	16	1	1/4
84	382	335	16	1	3/4
111	916	394	32	1	4/4
112	916	394	32	1	4/4
143	264	371	16	1	3/4
145	576	371	16	1	3/4
160*	596	184	16	1	2/4
161*	596	184	16	1	2/4
176	320	100	16	2	1/4
177	320	100	16	2	1/4
188	534	100	16	2	1/4
207	398	612	16	3	1/4
263	1200	70	16	1	3/4
264	1200	60	16	2	3/4
312	564	325	2,5	2	1/4
342	881	404	2,5	1	4/4
352	881	820	2,5	1	4/4

A1  30	A2  30	C1  8x35 40
E6  6	D1  6	I  1
G  1,5x26 40	L1  320 2	N1  5
R102  3,5x16 18	R3  3x20 23	R23  6,3x13 12
R24  7x50 8	R27  5,0x13 20	S3  3
S5  16	Q  11	Z10  300 2
P1  8	H28  3	M4  M4x22 6
		B5  10x50 1
		U  1

I

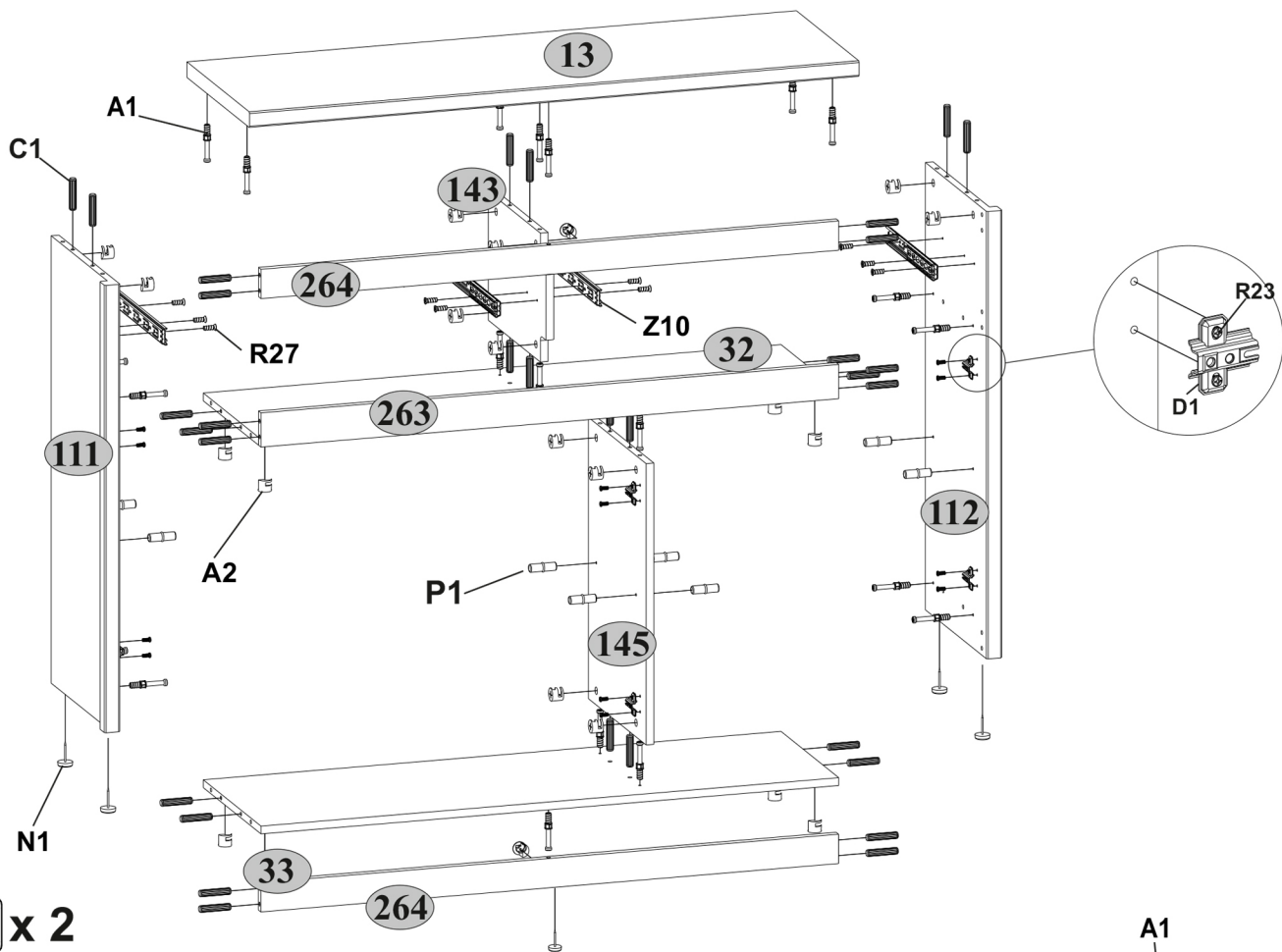

II x 2

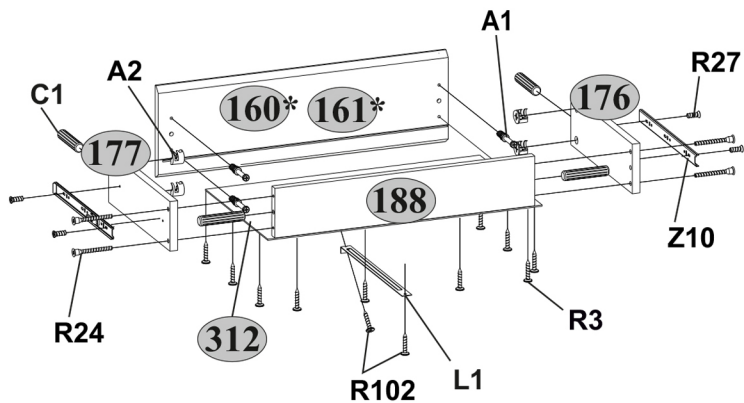
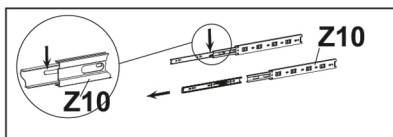

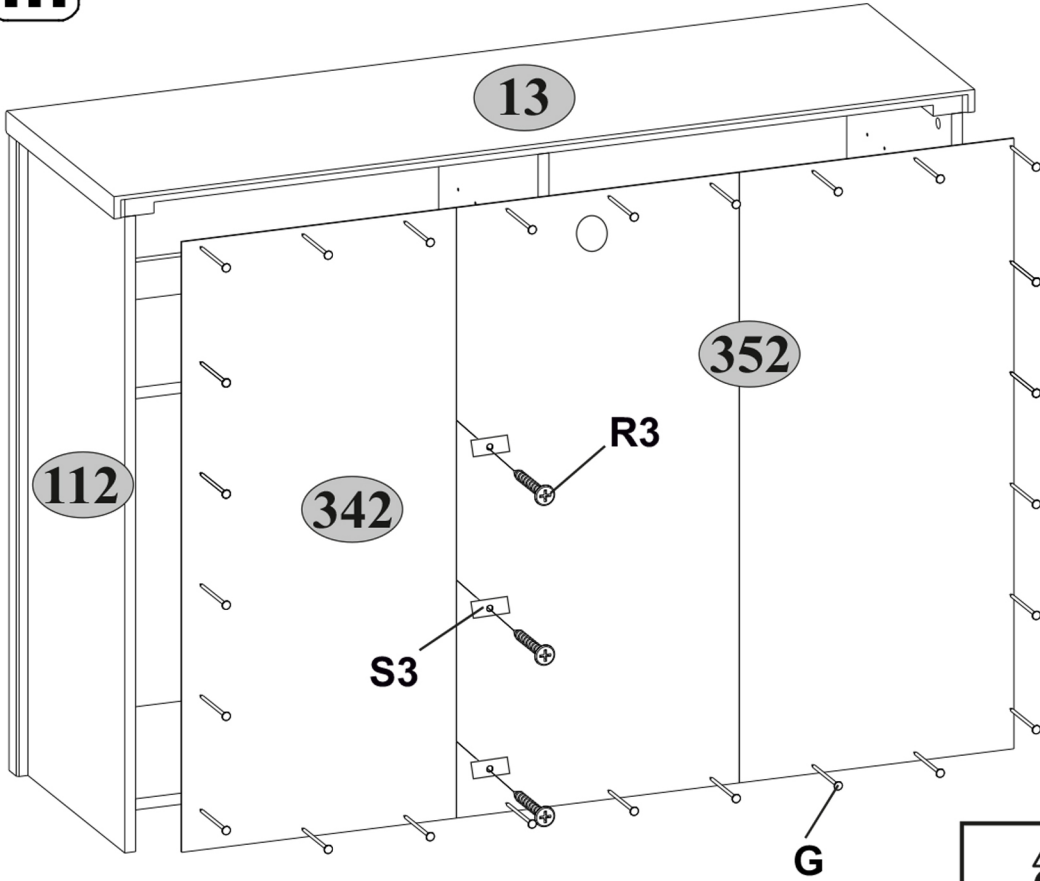

IV

